

DESCRIPTION: QUICK RELEASE - DIE CAST

SPECIFICATION:  
 MATERIAL: ZINC ALLOY, ZAMAK Z0410

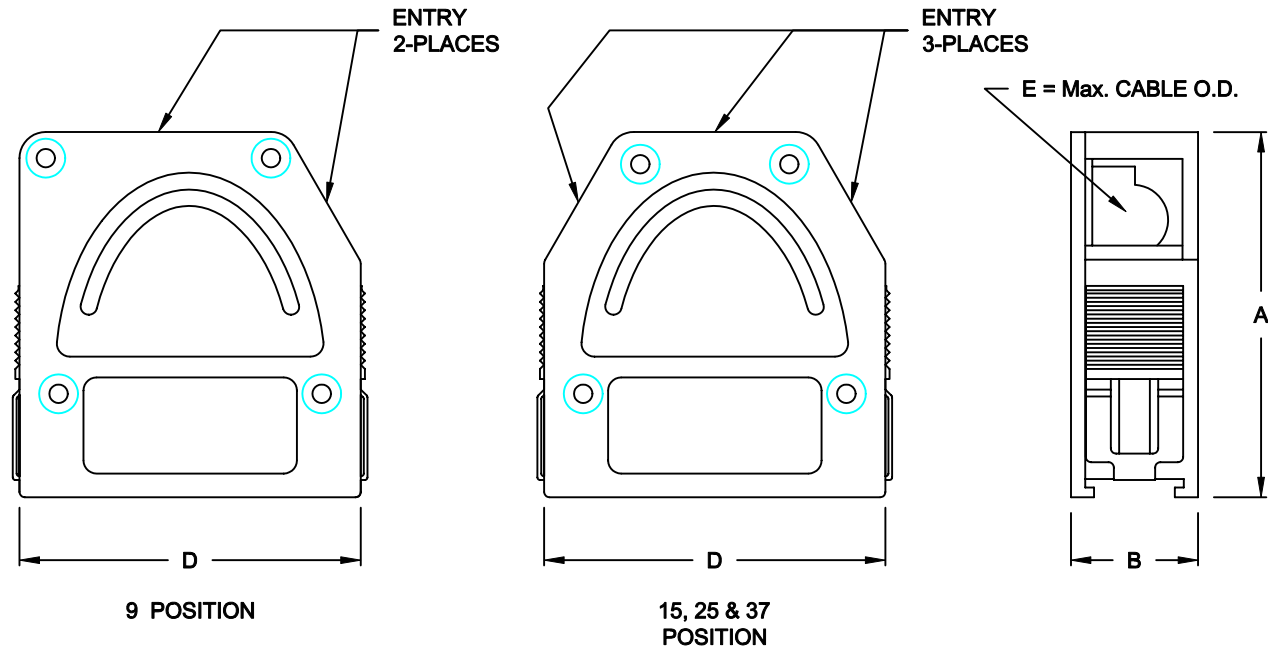

**BACKSHELL KIT INCLUDES:**

- (2) BACKSHELL HALVES
- (4) MOUNTING SCREWS
- (1) GROUNDING SCREW

\*\*\*\*\*  
 \*\*\* CABLE CLAMP ORDERED SEPARATELY \*\*\*  
 \*\*\* SEE SHEET 2 \*\*\*  
 \*\*\*\*\*

**955-YYY-030R121**

SERIES \_\_\_\_\_  
 POSITIONS \_\_\_\_\_  
 009  
 015  
 025  
 037  
 MATERIAL \_\_\_\_\_  
 030 = DIE CAST  
 RoHS COMPLIANT \_\_\_\_\_  
 R = HIGH TEMP. PROCESS  
 COLOR \_\_\_\_\_  
 12 = METAL(IZED)  
 PUT-UP \_\_\_\_\_  
 1 = KIT

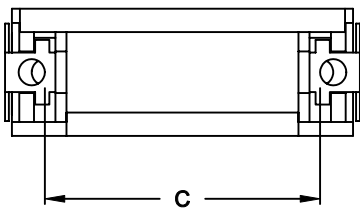

DIMENSIONS (IN.)					
No. OF PINS	A	B	C	D	E
09	1.740	0.606	0.984	1.299	0.354
15	1.740	0.606	1.312	1.626	0.394
25	1.740	0.606	1.852	2.165	0.433
37	1.740	0.606	2.500	2.815	0.433

**DO NOT SCALE FROM DRAWING**

	THESE DRAWINGS AND SPECIFICATIONS ARE THE PROPERTY OF NorComp AND SHALL NOT BE REPRODUCED, COPIED OR USED AS THE BASIS FOR THE MANUFACTURE OF SALE OF APPARATUS WITHOUT WRITTEN PERMISSION.		DRAWN: <b>C. SMITH</b>	DATE: <b>04-10-07</b>
			CHECKED:	DATE:
<b>NorComp</b>	SCALE: <b>1:1</b>	SHEET <b>1</b>	OF <b>2</b>	REV <b>0</b>
	DWG NO. <b>955-YYY-030R121</b>			

**RoHS COMPLIANT**

# CABLE CLAMPS ORDERED SEPARATELY

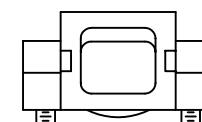
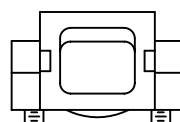
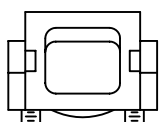
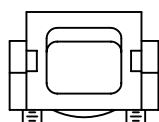
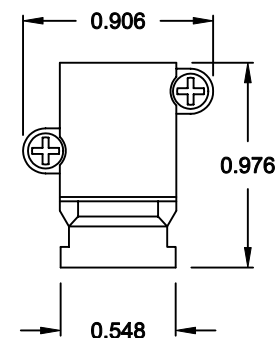
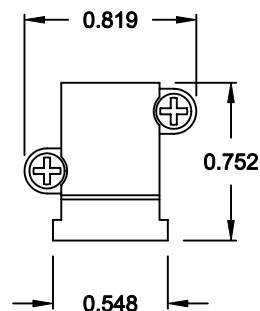
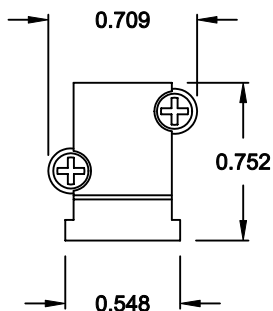
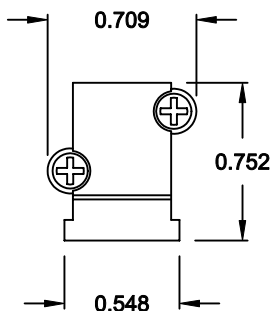
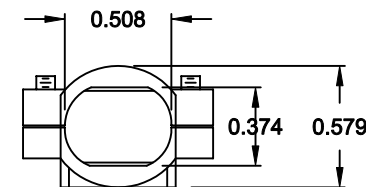
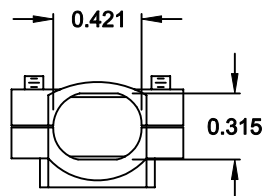
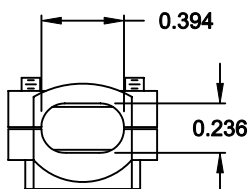
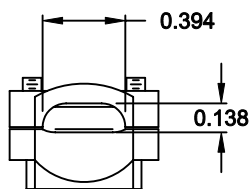

P/N 955-09-SR-4-7  
CABLE RANGE = 0.157 - 0.276

P/N 955-15-SR-7-10  
CABLE RANGE = 0.276 - 0.394

P/N 955-25-SR-9-12  
CABLE RANGE = 0.354 - 0.472

P/N 955-37-SR-11-14  
CABLE RANGE = 0.433 - 0.551

DO NOT SCALE FROM DRAWING



THESE DRAWINGS AND SPECIFICATIONS ARE THE PROPERTY OF NorComp AND SHALL NOT BE REPRODUCED, COPIED OR USED AS THE BASIS FOR THE MANUFACTURE OF SALE OF APPARATUS WITHOUT WRITTEN PERMISSION.

DRAWN: <b>C. SMITH</b>		DATE: <b>04-10-07</b>	
CHECKED:		DATE:	

# NorComp

SCALE: 1 : 1	SHEET 2 OF 2	REV 0
DWG NO. <b>955-YYY-030R121</b>		

# RoHS COMPLIANT